

# LEOPARD™ Compact Linear Line Array Loudspeaker



The LEOPARD compact linear line array loudspeaker is a member of Meyer Sound's award-winning LEO® Family of loudspeakers, designed to reproduce audio faithfully with tremendous power, superior intelligibility, and extremely low distortion. Like its bigger siblings LEO-M™ and LYON™, LEOPARD delivers

significantly lowering distortion while reducing power consumption and operating temperature. The onboard amplifier and control circuitry are contained in a single, field-replaceable module.

For low-frequency enhancement, LEOPARD pairs with Meyer Sound's 900-LFC low-frequency control element, which can be flown as part of LEOPARD arrays without transition hardware. The 900-LFC shares with LEOPARD the advantages of excellent power-to-size ratio, improved efficiency, and versatility.

In addition to working as a standalone system, LEOPARD can also be used as a supplemental fill loudspeaker in LEO-M and LYON systems.



the advantages of self-powered design, linear response, and precise directional control.

LEOPARD breaks new ground in loudspeaker array performance, providing exceptional phase coherence and consistent coverage in a light, compact cabinet, making it extremely versatile. Its innovative amplifier, driver, and horn designs ensure that LEOPARD systems reproduce any sound source with linearity over a wide dynamic range, from speech and classical music to rock and EDM. LEOPARD loudspeakers are optimized for use with minimal processing, yielding excellent performance right out of the box.

LEOPARD is portable and easy to configure. Its low weight and narrow profile make it well-suited for small- to medium-sized touring acts and fixed installations, where scalability and ease of rigging are essential. A newly-designed class D amplifier affords unprecedented efficiency to LEOPARD,

LEOPARD systems can be driven by Meyer Sound's Galileo Callisto™ 616 array processor, which provides matrix routing, alignment, and processing for array components. To guarantee optimum performance, LEOPARD systems should be designed with Meyer Sound's MAPP™ software. LEOPARD and 900-LFC loudspeakers work with Meyer Sound's RMS™ remote monitoring system, which provides comprehensive monitoring of system parameters from a Mac® or Windows®-based computer.

LEOPARD includes Meyer Sound's QuickFly® rigging with captive GuideALinks™, which allows easy setting of splay angles from 0.5 to 15 degrees. Rigging options include the MG-LEOPARD/900 multipurpose grid, MCF-LEOPARD caster frame, PBF-LEOPARD pull-back frame, and MTF-LYON/LEOPARD transition frame.



## FEATURES & BENEFITS

- Compact cabinet with small footprint and extraordinary power-to-size ratio
- High peak power output with exceptional linearity and transient reproduction, at any output level, with extremely low distortion
- Self-powered for simplified setup and increased reliability
- Flexible rigging and transport options
- Integrates easily with Meyer Sound's LYON, 900-LFC, and 1100-LFC loudspeakers

## SOLUTIONS

- Small- to medium-sized touring and fixed installations
- Clubs, theatres, houses of worship, corporate AV, and theme parks
- Downfill, midfill, sidefill, and outfill for LYON; midfill, sidefill, and outfill for LEO-M

## LEOPARD ACCESSORIES

**MG-LEOPARD/900 MULTIPURPOSE GRID** Flies LEOPARDs, 900-LFCs, and mixed arrays. Also supports LEOPARD and 900-LFC groundstack configurations.

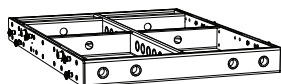

**MVP MOTOR VEE PLATE** Attaches to MG-LEOPARD/900 grid and fine tunes horizontal aim of LEOPARD and 900-LFC arrays.

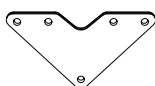

**PBF-LEOPARD PULL-BACK FRAME** Provides pull-back for extreme downtilt of flown LEOPARD and 900-LFC arrays, and allows additional downtilt in groundstacked arrays.



**MCF-LEOPARD CASTER FRAME** Safely transports up to four LEOPARDs, making it easy to assemble and disassemble arrays in blocks of three or four cabinets.

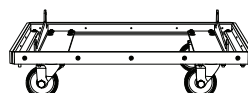

**CALLISTO 616 ARRAY PROCESSOR** Drives and aligns Meyer Sound array systems with 6 x 16 matrix processing, delay integration, and EQ, using Compass software.

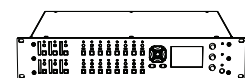

**MDM-5000 DISTRIBUTION MODULE** Integrates routing of audio, power, and RMS to loudspeaker arrays.

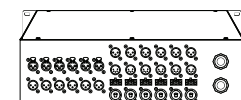

## LEOPARD SPECIFICATIONS

### ACOUSTICAL<sup>1</sup>

Operating Frequency Range <sup>2</sup>	55 Hz – 18 kHz
Phase Response	92 Hz – 18 kHz ±30 degrees

### TRANSDUCERS

Low Frequency	Two 9-inch long-excursion cone drivers
High Frequency	One 3-inch compression driver coupled to a constant-directivity horn through a patented REM <sup>®</sup> manifold

### AUDIO I/O

Connectors <sup>3</sup>	XLR 3-pin or 5-pin female input with male loop output
-------------------------	---

### AMPLIFIER

Type	3-channel, open-loop, class D
------	-------------------------------

### AC POWER

Connectors	powerCON 20 input with loop output
Safety Rated Voltage Range	100–240 V AC, 50–60 Hz
Turn-on/off Points	90 V AC turn-on, no turn-off; internal fuse-protection above 265 V AC
Max. Long-Term Cont. Current	3.0 A rms (115 V AC); 1.5 A rms (230 V AC); 3.4 A rms (100 V AC)

### RMS NETWORK

Equipped with 2-conductor, twisted-pair network, reporting all amplifier operating parameters to host computer

### PHYSICAL

Dimensions	26.93 inches W x 11.11 inches H x 21.66 inches D (684 mm x 282 mm x 550 mm)
Weight	75 lbs (34.0 kg)
Enclosure	Multi-ply hardwood with black textured finish
Protective Grille	Hex-stamped steel with acoustical black mesh
Rigging	Endframes with captive GuideALinks (0.5 to 15-degree splay angles), quick-release pins, and detachable side and rear handles
Load Ratings	MG-LEOPARD/900 multipurpose grid flies 20 LEOPARDS (5:1 safety factor) or 16 LEOPARDS (7:1 safety factor), with some restrictions

### NOTES

- Loudspeaker system predictions for coverage and SPL available in Meyer Sound's MAPP XT software.
- Recommended maximum operating frequency range. Response depends on loading conditions and room acoustics.
- XLR 5-pin connectors accommodate both balanced audio and RMS signals.

LEOPARD — 04.243.004.02 B

Copyright © 2015  
Meyer Sound Laboratories Inc.  
All rights reserved

MEYER SOUND LABORATORIES INC.  
2832 San Pablo Avenue  
Berkeley, CA 94702

+1 510 486.1166  
techsupport@meyersound.com  
www.meyersound.com

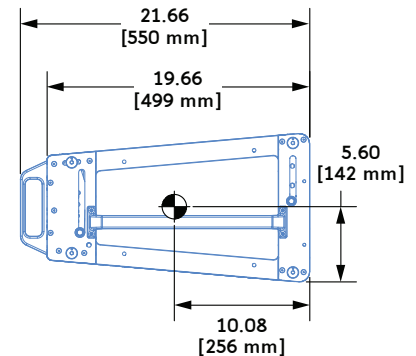
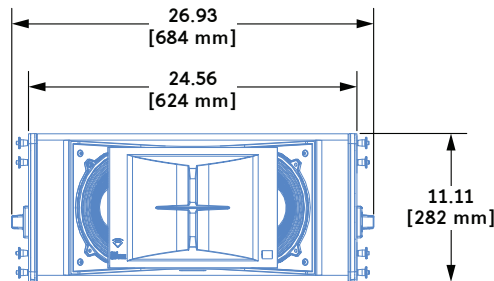
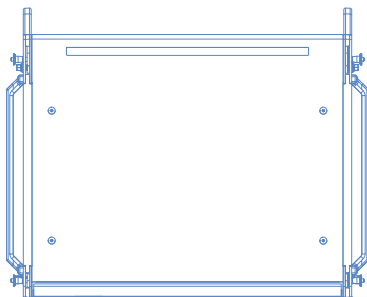
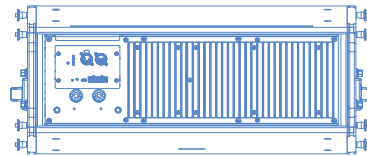

## ARCHITECT SPECIFICATIONS

The loudspeaker shall be a compact, self-powered, linear, low-distortion, line array loudspeaker. Its transducers shall include two 9-inch long-excursion cone drivers and one 3-inch compression driver coupled to a constant-directivity horn through a patented REM manifold.

The loudspeaker shall incorporate internal processing and a 3-channel, open-loop, class D amplifier. Processing shall include equalization, phase correction, driver protection, and signal division. Performance specifications for a typical production unit shall be as follows, measured at 1/3-octave resolution: operating frequency range, 55 Hz to

18 kHz; phase response, 92 Hz – 18 kHz ±30 degrees. Audio connectors shall be XLR 3-pin, female and male, accommodating balanced audio, or XLR 5-pin, accommodating both balanced audio and RMS.

The internal power supply shall perform EMI filtering, soft current turn-on, and surge suppression. Power requirements shall be nominal 100, 110, or 230 V AC line current at 50–60 Hz. UL and CE operating voltage range shall be 100–240 V AC at 50–60 Hz. AC power connectors for input and loop output shall be powerCON 20. Maximum long-term continuous current draw shall be 3.0 A rms at 115 V AC, 1.5 A rms at 230 V AC and 3.4 A rms at 100 V AC. The loudspeaker shall

include an RMS remote monitoring system module.

Components shall be mounted in an optimally tuned, vented enclosure constructed of multi-ply hardwood with a black textured finish. The enclosure shall include endframes with captive GuideALinks for linking units in vertical arrays at splay angles from 0.5 to 15 degrees. The front protective grille shall be powder-coated, hex-stamped steel with black mesh. Dimensions shall be 26.93 inches wide x 11.11 inches high x 21.66 inches deep (684 mm x 282 mm x 550 mm). Weight shall be 75 lbs (34.0 kg).

The loudspeaker shall be the Meyer Sound LEOPARD.